



Support of Part-whole Relations in Query Answering

Yannis Velegarakis

University of Trento

With Francesco Guerra, Ekaterini Ioannou and Piotr Kozikowski

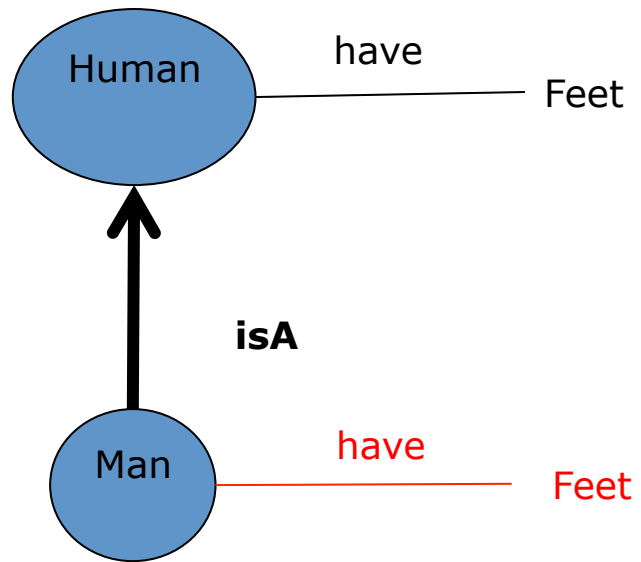

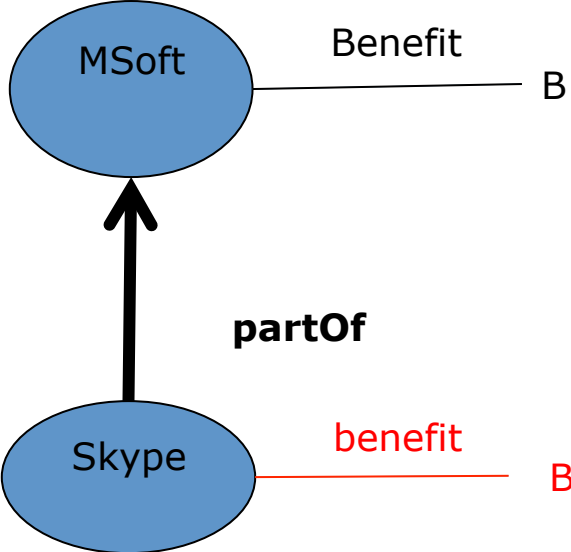

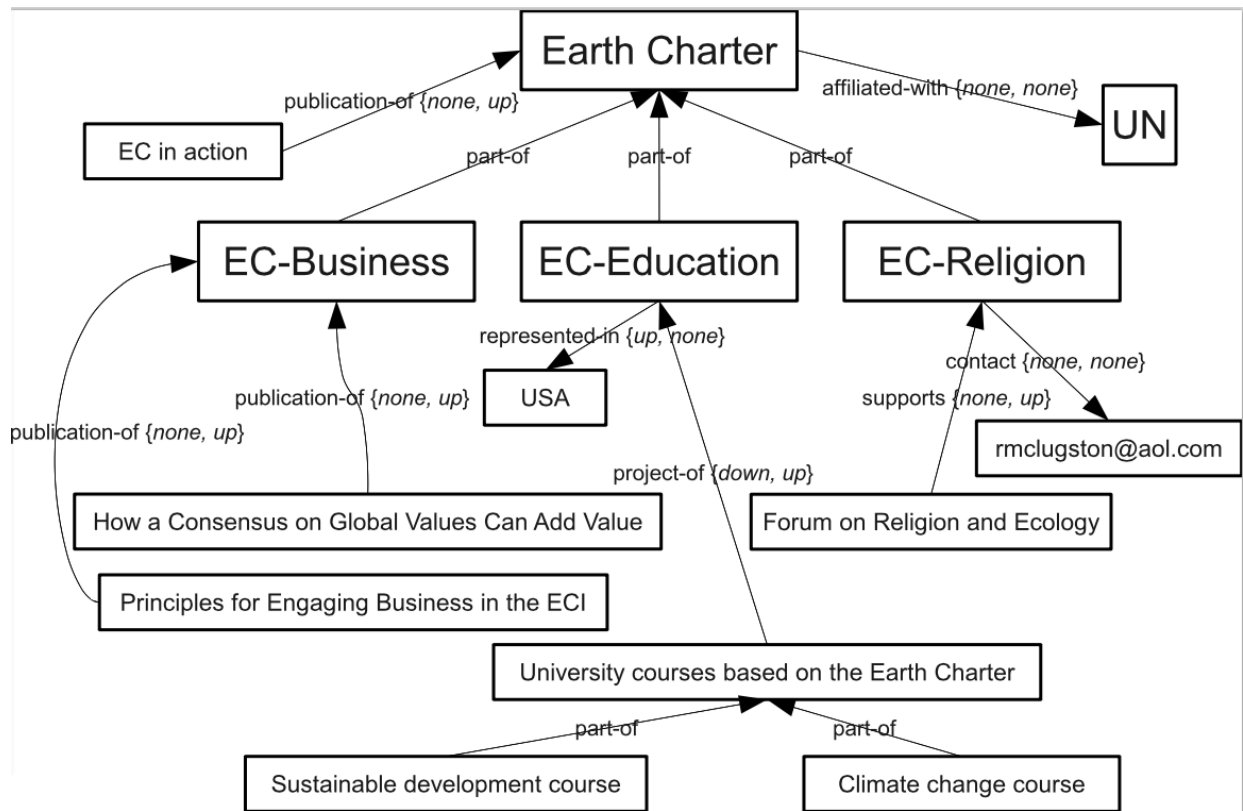

Data Model

- Database: $\langle E, G \rangle$
 - E: Entities
 - G: $E \times N \times \{E \cup V\}$
 - ◆ N: Names
 - ◆ V: Atomic Values
- atom :- *set of atoms*
 - atom is: $e(n_1:v_1, \dots, n_k:v_k)$

\$pub(related-to:\$org) :- \$pub(publication-of: \$ngo), \$ngo(affiliated-with: \$org)

Data Model - Extended

- Database: $\langle E, G, P \rangle$

- E: Entities

- G: $E \times N \times \{E \cup V\}$

- ◆ N : Names

- ◆ V: Atomic Values

- P: $E \times E$

(**part-of** relationships)

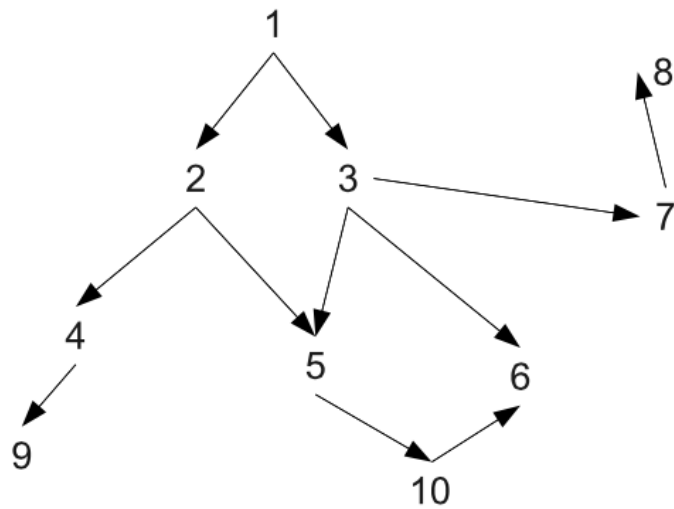

Data Model - Extended

- Database: $\langle E, G, P \rangle$

- E: Entities

- G: $E \times N \times \{E \cup V\} \times T \times T$

- ◆ N : Names

- ◆ V: Atomic Values

- P: $E \times E$ (part-of relationships)

- T: {up, down, both, none}

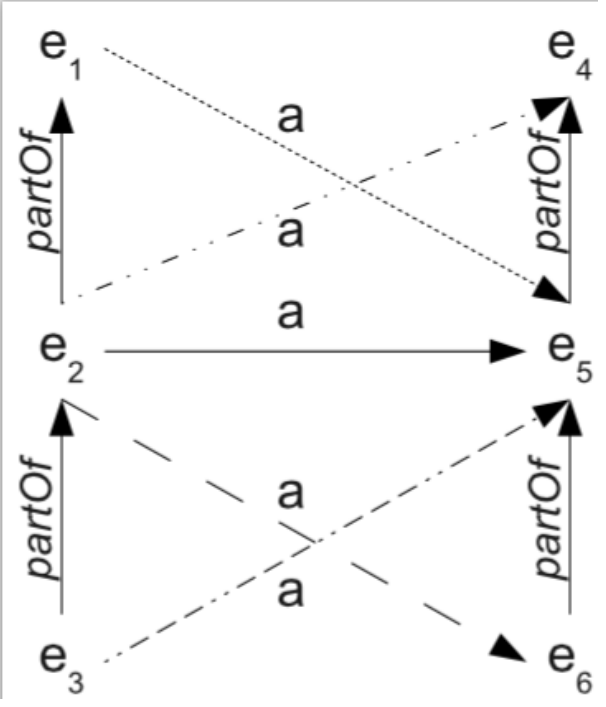

Data Model - Extended

- Database: $\langle E, G, P \rangle$

- E: Entities

- G: $E \times N \times \{E \cup V\} \times T \times T$

- ◆ N : Names

- ◆ V: Atomic Value

Attribute: $\langle e, n, v, et, vt \rangle$

- P: $E \times E$ (**part-of** relationships)

- T: $\{\text{up, down, both, none}\}$

- Query remains the same

- BUT with different semantics: The inferred atoms

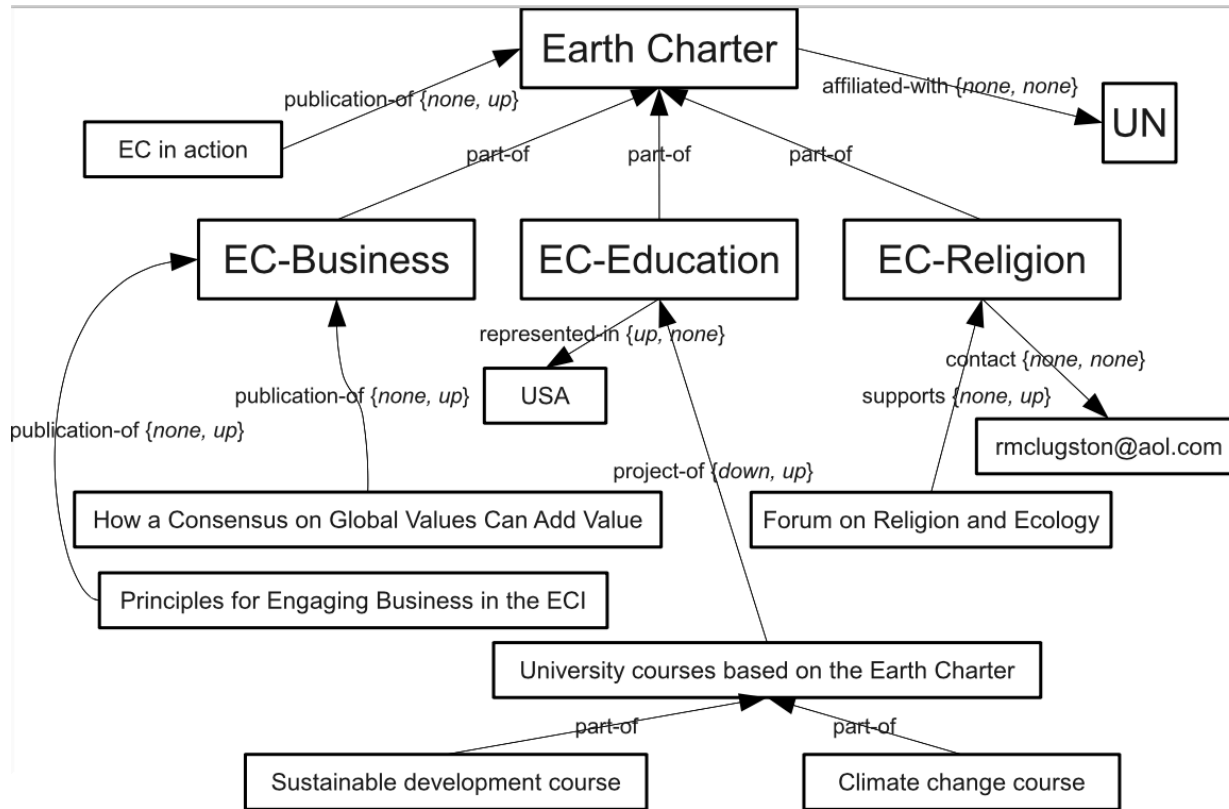

\$pub(publication-of: Earth Charter) :- \$pub(publication-of: Earth Charter)

Solution

- Closure based on part-of relationships

Solution A

- Closure based on part-of relationships
- Naïve – Lazy Approach
 - Do Nothing during updates
 - ◆ Check only the part-of cycles during insertion
 - break query into singleton atoms
 - ◆ $e(n:v)$, $e(?:v)$, $e(?,?)$, $?(n,?)$, ... etc.
 - ◆ Optimize (getting rid of redundancies)

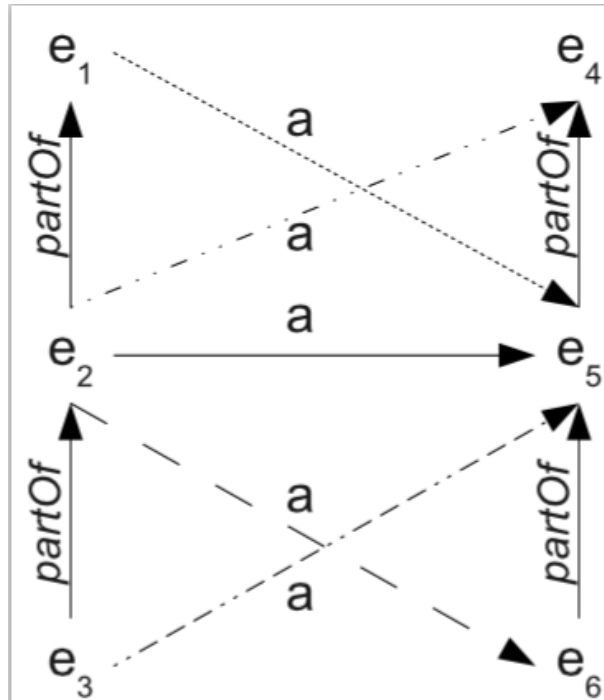

e2("a",?)

Solution B

- Closure based on part-of relationships
- Total Materialization Approach
 - Infer all derived singleton atoms during update
 - ◆ Insert them in the database
 - Query is as usual

Part-of Index

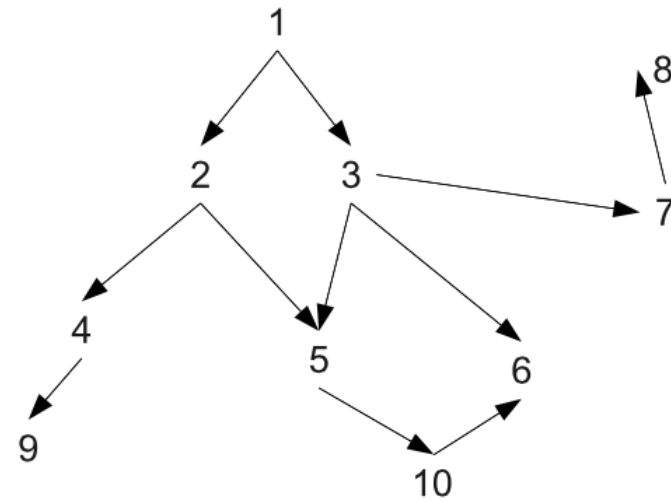

1	{2,3}	{4,5,6,7,8,9,10}	{}	{}
2	{4,5}	{6,9,10}	{1}	{}
3	{5,6,7}	{8,10}	{1}	{}
4	{9}	{}	{2}	{1}
5	{10}	{6}	{2,3}	{1}
6	{}	{}	{3,10}	{1,2,5}

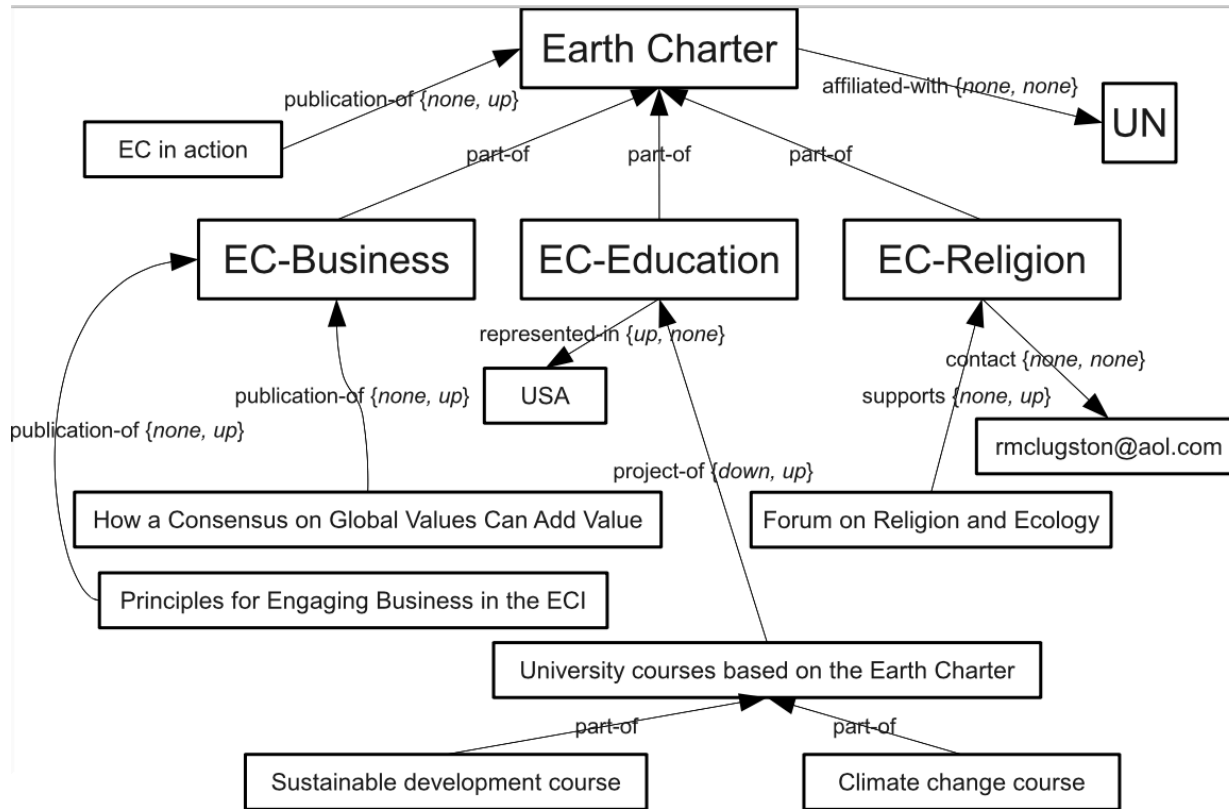

\$pub(publication-of: Earth Charter) :- \$pub(publication-of: Earth Charter)

Transitive Attribute Index

e_1, n_1, v_1	$eu=true, ed=true, vu=false, vd=false$
e_1, n_2, v_2	$eu=true, ed=false, vu=false, vd=false$
e_1, n_3, v_3	$eu=false, ed=true, vu=false, vd=false$
e_2, n_4, v_4	$eu=false, ed=false, vu=true, vd=true$
e_2, n_5, v_5	$eu=false, ed=false, vu=true, vd=false$
e_2, n_6, v_6	$eu=false, ed=false, vu=false, vd=true$

eu

e_1	e_1, n_1, v_1
e_1	e_1, n_3, v_3

ed

e_1	e_1, n_1, v_1
e_1	e_1, n_2, v_2

Solution C

- Closure based on part-of relationships
- B+tree

Solution D

- Closure based on part-of relationships
- Compute-as-you-go

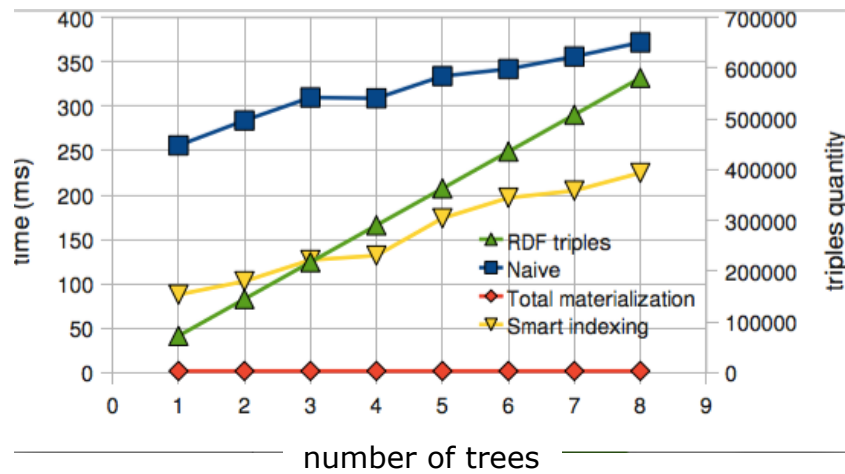
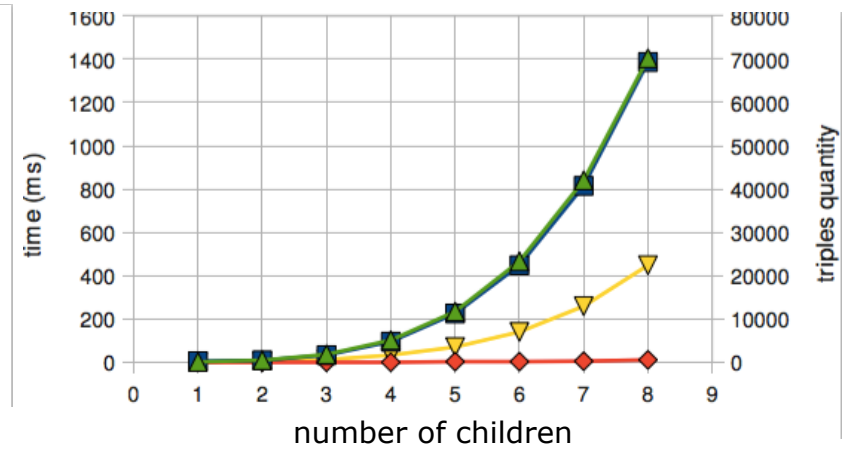
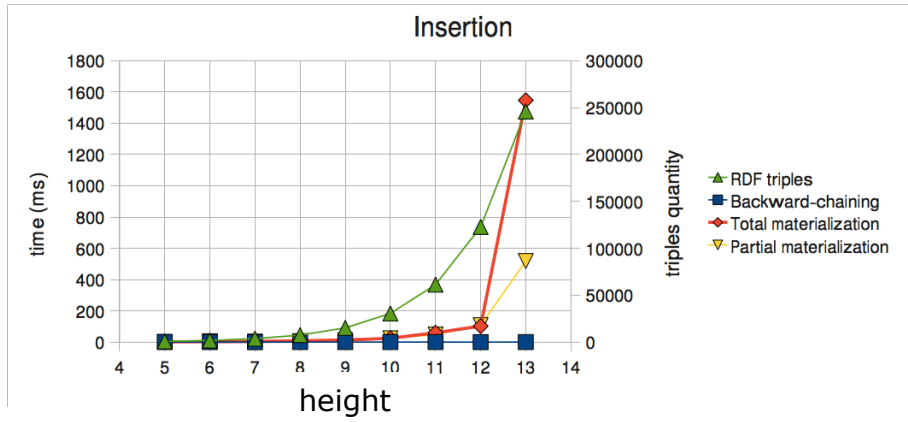

Why Care?

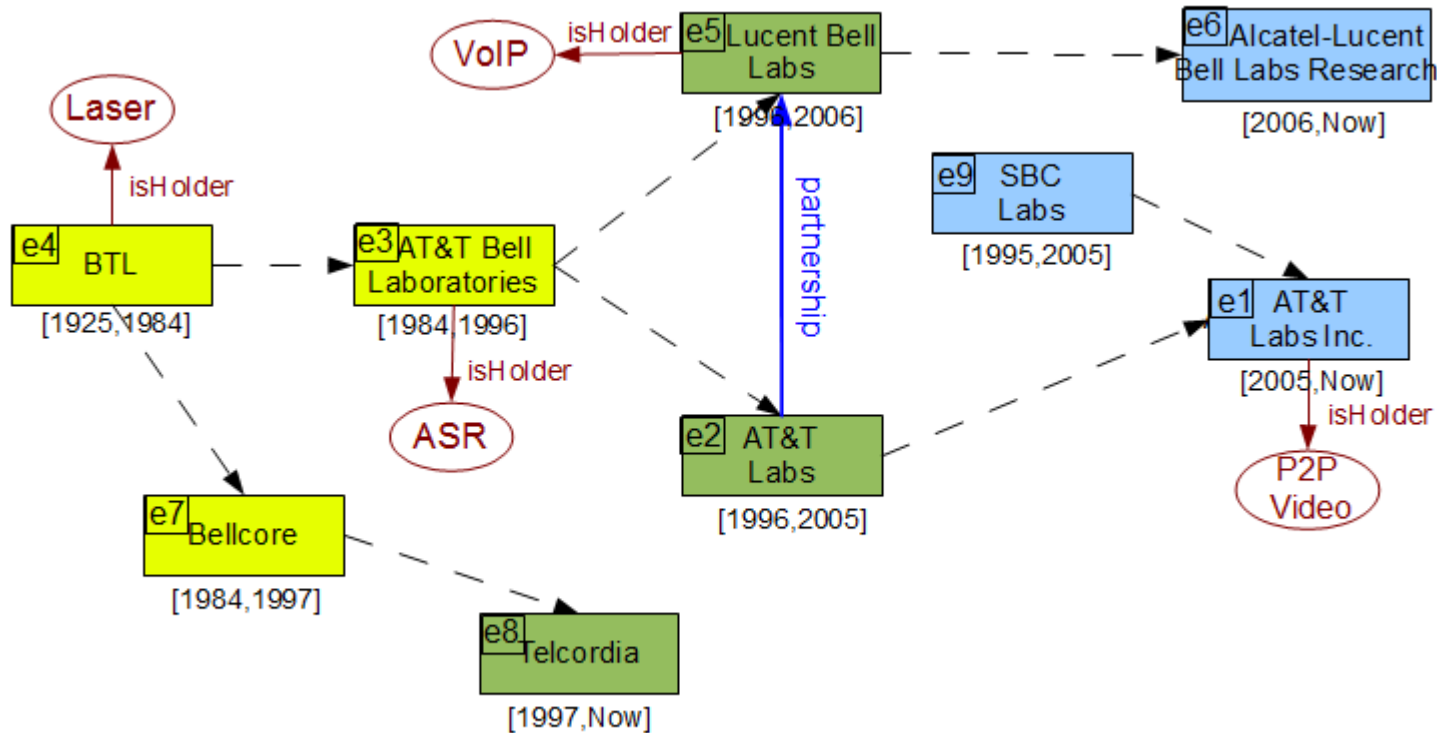

Find the patents of AT&T Labs Inc.:
\$x(isHolder:\$y):-\$x(name:AT&T Labs Inc; isHolder:\$y)



Thank you for your attention!